

STEP:1

Download the X-HOUSE App on your app store or the QR code provided in the box of the Gate1® smartphone gate or garage kit.

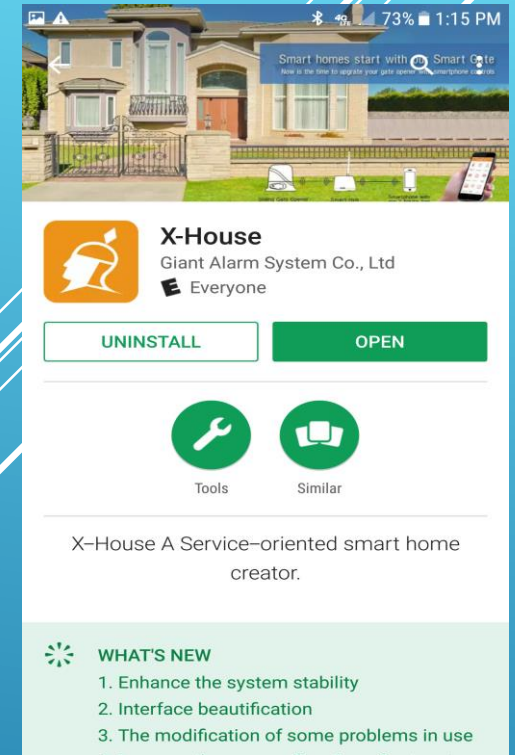
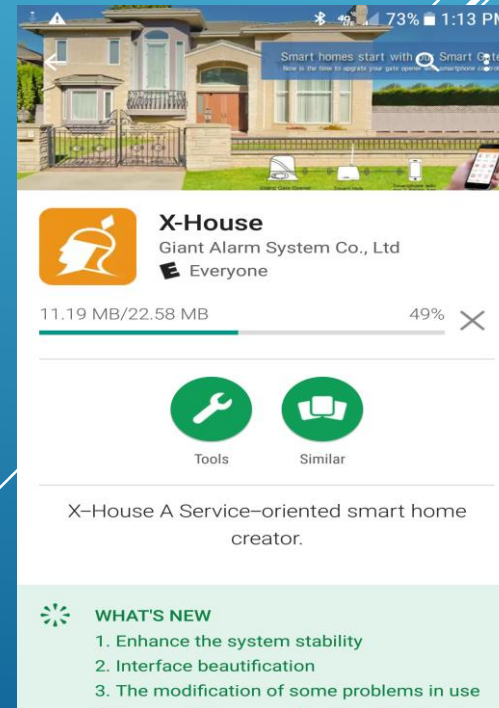
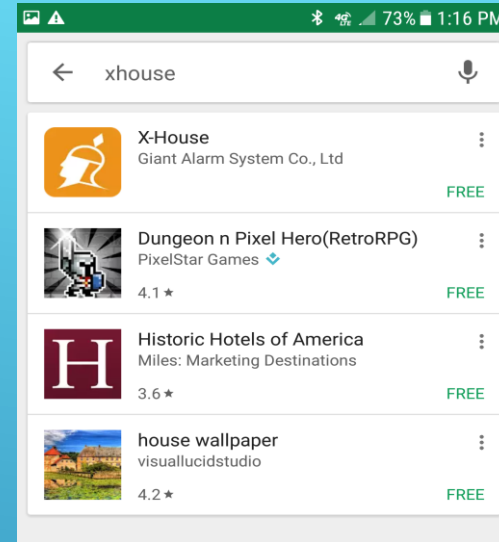

STEP:2

Set up your account
with X-HOUSE.

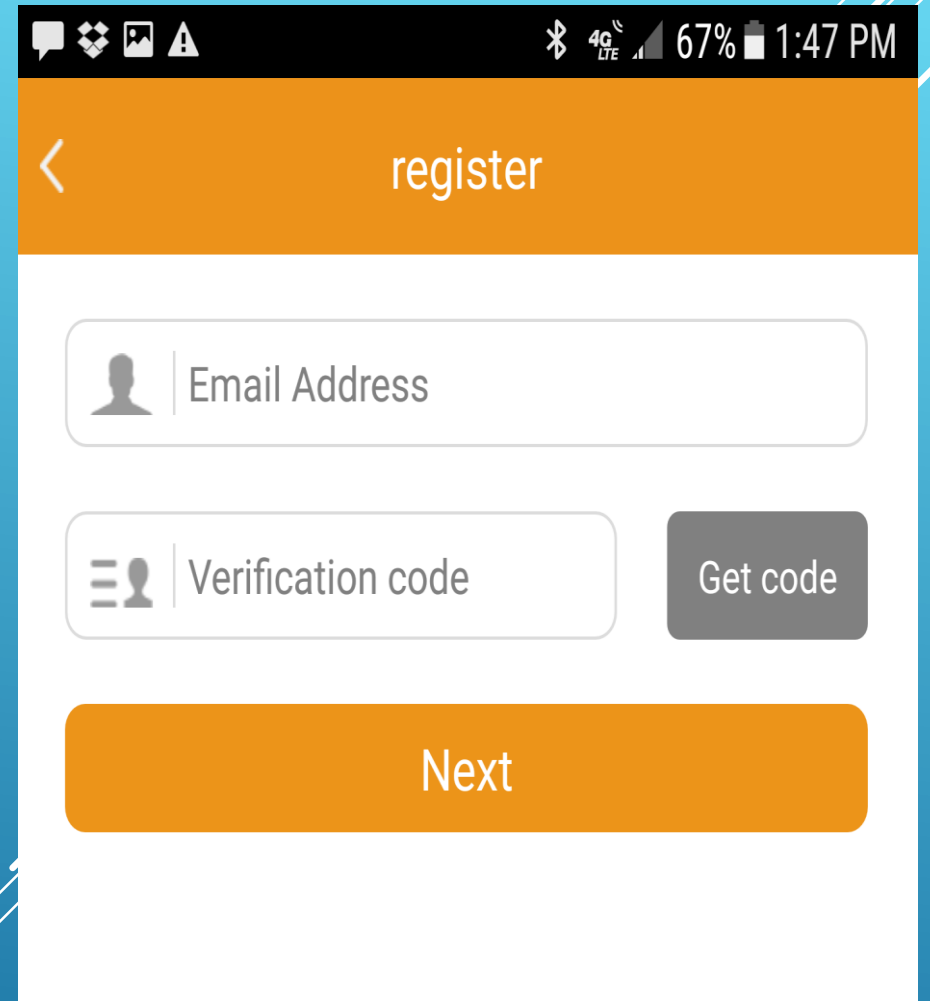

The screenshot shows a mobile application interface for registration. At the top, there is a black status bar with icons for messages, Wi-Fi, cellular signal, and battery, along with the time 1:47 PM and 67% battery. Below this is an orange header bar with a back arrow on the left and the word "register" in the center. The main content area is white and contains three input fields: "Email Address" with a person icon, "Verification code" with a person icon and a "Get code" button to its right, and a large orange "Next" button at the bottom.

STEP:3

Install your Gate1® receiver to your gate or garage opener.

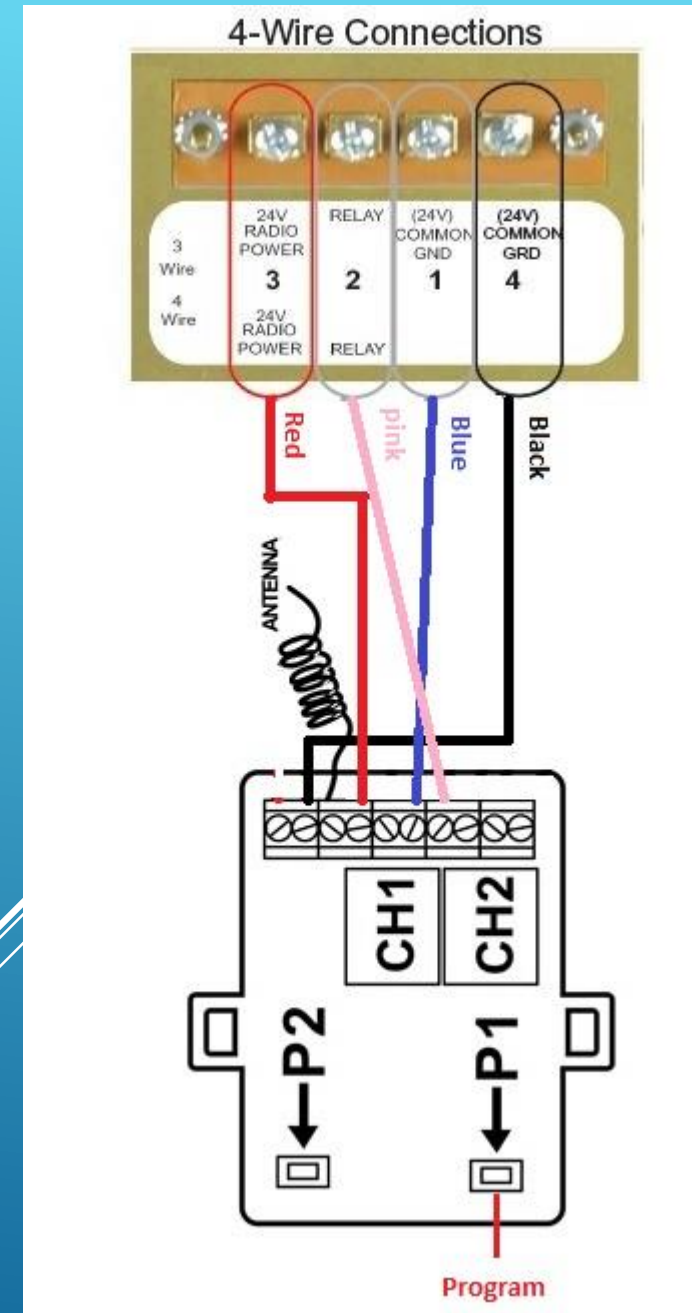

STEP:4

Install the antenna, Ethernet cable, and the power supply to the Gate1® Hub then install the other side of the Ethernet cable to the modem or router. Then install the power supply to your home electricity. Make sure the RED led is on solid.



STEP:5

Once inside the APP you will be prompted to choose which hub, you will choose (New LAN Hub)

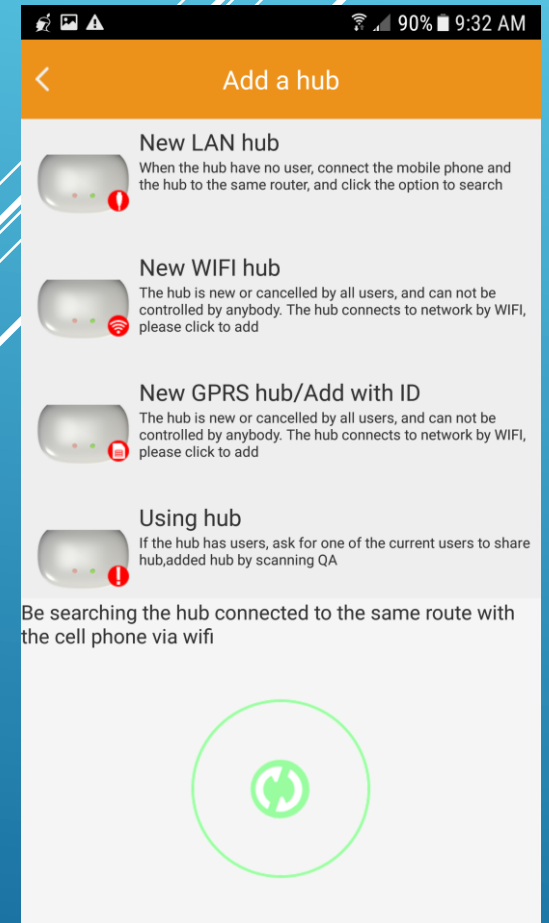
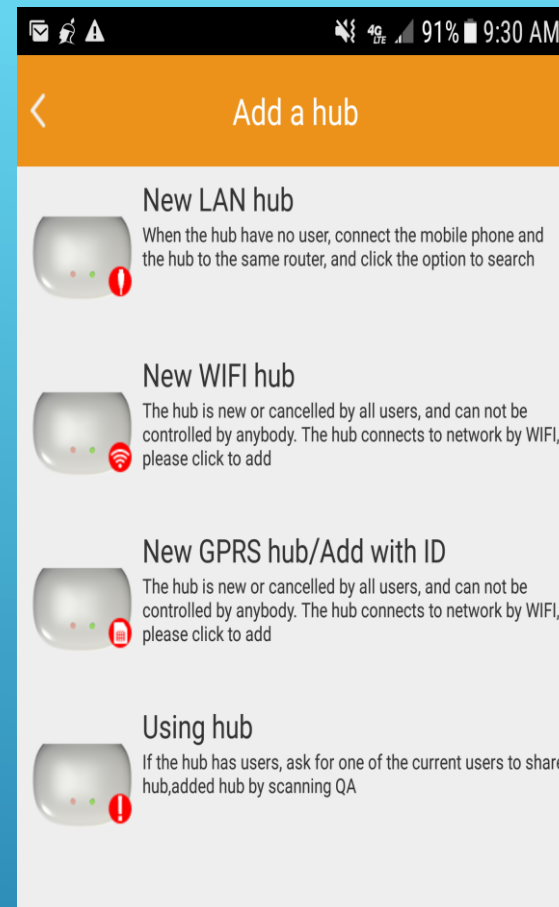

STEP:6

Open your app and make sure it is online, you should see 1 user and 1 key device. At this time you press the 1 key button and the gate or garage opener will be activated.

